

Universal Manufacturing and Distribution

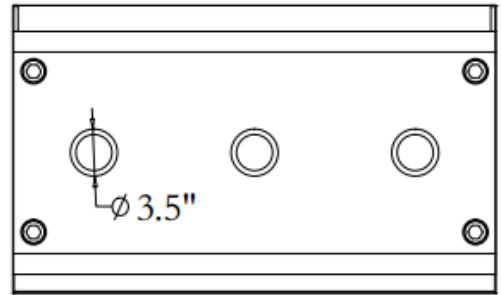

Item No	W*L (Bowl)	W*L (Overall)
BS-C3T2424	24 x 24	72 x 27.5

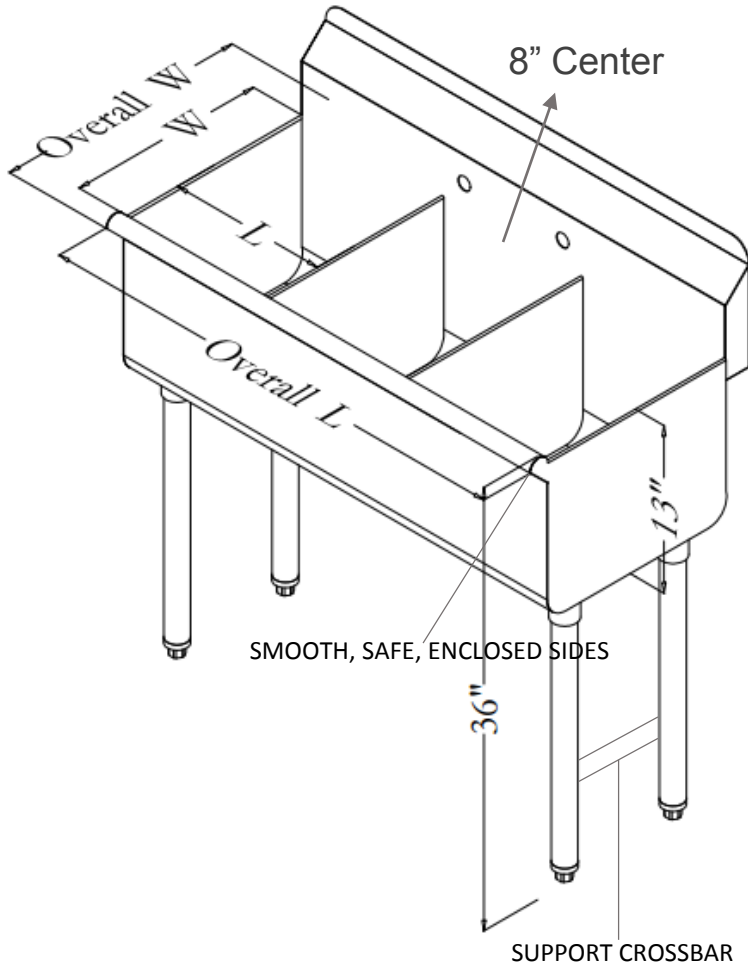

NOTE:

1. ALL VISIBLE WELDS TO BE GROUND SMOOTH AND POLISHED TO A MATCHING FINISH.
2. ALL NON-VISIBLE WELDS TO BE GROUND SMOOTH AND PAINTED WITH A F.I. APPROVED PAINT
3. ALL EDGES TO BE SMOOTH AND FREE FROM BURRS
4. ALL FABRICATION TECHNIQUES AND COMPONENTS TO BE APPROVED BY F.I. PRIOR TO FABRICATION.