

Product Line	TYPE K	SPEC KDONUT 03-2013
Model	Donut Dispenser	

TYPE K DONUT DEPOSITOR

FEATURES

Belshaw's Type K Donut Depositor is ideal for creating perfectly formed cake donuts. The Type K is quick and easy to use and provides accurate portion control at a variety of sizes with a single plunger.

Belshaw's Type K depositors are designed to be mastered by the novice in minutes. Operation is easily accomplished with minimal waste, and consistent deposits are easily delivered time after time.

The Type K offers 6 volume settings located on the handle. Typical weight range is from 1.2 - 1.8 oz (34 - 50g). An consistently shaped product is delivered time after time.

The hopper holds 5.5 lbs of batter (2.5 kg), allowing approximately 58 deposits of 1½ oz (43g). Each hopper is constructed of aluminum to reduce weight. Each plunger and built-in cylinder is constructed of stainless steel to assure durability. The entire unit is corrosion resistant and easy to clean.

Two plungers are available, a 1-9/16" plunger for standard size donuts and a 1" plunger for mini donuts. In addition the Donut Depositor accepts Belshaw plunger attachments to a plain plunger. These attachments divide the donut deposit into 2, 3 or 4 pieces (as pictured on facing page)

The Type K Pancake Dispenser is NSF-C2 certified.

ACCESSORIES

- Item #K-1016WSS: Type K Holder. The stainless steel Type K Stand is simple, easy to keep clean, and helps keep your pancake dispenser safe from damage.
- Item #K-1011S: Star Plunger (1-9/16" diameter). Produces a well rounded Ring Donut with a star shape in the center. (See following page)
- Dunkette, Nugget or Ball attachments: economical attachments that slide onto a plain or star plunger, to make smaller donuts. (See following page)



Type K Donut Depositor
with Holder (Item #K-1016WSS)

90 Years of Quality Donut & Bakery Equipment

BELSHAW ADAMATIC BAKERY GROUP

814 44th St NW, Suite 103
Auburn, WA 98001 USA
PART OF ALI GROUP S.P.A.

CONTACT

800.578.2547 (USA/CANADA)
(+1)206.322.5474 Worldwide
service@belshaw.com

WEB

www.belshaw-adamatic.com
www.belshaw.com
www.adamatic.com

SPEC
KDONUT
03-2013

CONSTRUCTION

- Aluminum hopper
- Stainless steel plunger and cylinder

PLUNGER

- 1-9/16" plain plunger (makes standard ring donuts)

CAPACITY AND DEPOSIT WEIGHTS

- Hopper capacity: up to 5.5 lbs (2.5 kg) batter weight
- Deposits per hopper when full: approx 58 x 1½ oz (43g) deposits
- 6 weight settings on handle
- Weight range 1/2 – 1.8 oz (34 – 50g) per deposit
- Weights are approximate and can vary

WEIGHT AND DIMENSIONS

- Overall height: 12-7/8" (33 cm)
- Hopper diameter: 6½" (16.5 cm)

SHIPPING DATA

- Carton width: 7½"
- Carton depth: 7½"
- Carton height: 14½"
- Carton weight: 3 lbs

MODEL SELECTION

- Item Nbr 8504022: Type K Donut Depositor with 1-9/16" plunger
- Item Nbr 8504052: Type K Donut Depositor with single 1" plunger (for mini donuts)
- Item Number K-1016WSS: Holder for Type K:







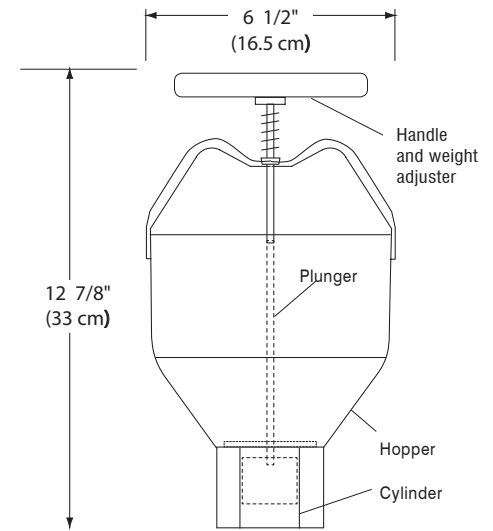



CERTIFICATION



Certified by NSF(C2)



PLUNGER AND ATTACHMENT SELECTION GUIDE

Item Number	Plunger / Attachment	Plunger	Donut type
#8504022 INCLUDES TYPE K WITH PLAIN PLUNGER 1-9/16	PLAIN PLUNGER 1-9/16" DIAMETER For standard Ring donuts. Also makes "Old Fashion" donuts using Old Fashion donut mix. Size is adjustable using weight adjuster on Type K		
#8504052 INCLUDES TYPE K WITH 1" PLUNGER	MINI DONUT PLUNGER 1" DIAMETER For mini donuts. Size is adjustable using weight adjuster on Type K		
DR42-1018x1.563 (Option)	DUNKERETTE ATTACHMENT Attaches to a Plain Plunger. Forms 2 half-donuts as shown. Size is adjustable using weight adjuster on Type K		
DR42-1016x1.563 (Option)	NUGGET ATTACHMENT Attaches to a Plain Plunger. Produces 3 separate or joined balls, depending on the height of the hopper and the type of mix. Size is adjustable using weight adjuster on Type K		
DR42-1017x1.563 (Option)	BALL ATTACHMENT Attaches to a Plain Plunger. Produces 4 separate balls, or joined balls, depending on the height of the hopper and the type of mix. Size is adjustable using weight adjuster on Type K		

90 Years of Quality Donut & Bakery Equipment

BELSHAW ADAMATIC BAKERY GROUP

814 44th St NW, Suite 103
Auburn, WA 98001 USA
PART OF ALI GROUP S.P.A.

CONTACT

800.578.2547 (USA/CANADA)
(+1)206.322.5474 Worldwide
service@belshaw.com

WEB

www.belshaw-adamatic.com
www.belshaw.com
www.adamatic.com