



# BEVERAGE-AIR

3779 Champion Blvd., Winston-Salem, NC 27105  
1-888-845-9800 Fax# 1-336-245-6453  
<http://www.Beverage-Air.com>

## Commercial Refrigeration Equipment General Specification

### DP SERIES "DELI/PIZZA" PREP TABLES

The all-purpose "raised rail," Deli/Pizza Prep Table assures that condiments are held below 41°F and above freezing. It eliminates any chance of freezing product with lids open or closed and prevents unsanitary defrosting associated with cold wall, refrigerated rails.

### CABINET CONSTRUCTION

Exterior construction includes heavy-duty stainless steel finish on front, sides, top, door(s) and grille. Insulated lid assemblies are made of matching stainless steel. Cabinet back and bottom are constructed of galvanized steel. Interior liner is made of anodized aluminum for superior resistance to corrosion.

Doors are mounted to face of cabinet on cartridge style hinges permitting them to self close under their own weight. Hinges also allow doors to stay open 120° and permit easy door removal for service and cleaning if required. A plug in type vinyl magnetic gasket is attached to each door for positive seal. Door handle is made from extruded aluminum with a black anodized finish. It is contoured to permit easy opening of doors with fingers from both top and bottom of handle.

Cabinet insulation is CFC free foamed-in-place polyurethane of two-inch minimum thickness. Three-inch casters, 2 with brakes, are standard. Six-inch casters or legs are optional.

Cutting board supplied with cabinet is 19" wide constructed of high-density white polyethylene plastic. It is readily removable for cleaning. Two epoxy-coated steel wire shelves are supplied behind each door as standard. Units will accept pans up to 6" deep. Pans are not included.

### REFRIGERATION

Systems are designed using CFC free R134a refrigerant and capillary tube between condenser and evaporator. Recirculated, forced air from evaporator is discharged 3 ways. Slightly over and mostly under pans which are recessed approximately 3" from top of raised rail, and into the cabinet directly. Coils are plastic coated for maximum corrosion protection. Automatic condensate evaporator is provided to eliminate the need of floor drains.

### ELECTRICAL CONNECTION

Units pre-wired at factory and include 8' long cord and plug



Item No. \_\_\_\_\_  
Quantity \_\_\_\_\_

## FOOD PREPARATION SERIES DELI/PIZZA PREP TABLES DP SERIES

MODELS:  
DP46  
DP67  
DP93  
DP119



DP46



DP67



DP93



DP119

Available From:



<b>Model Specified</b> _____	<b>Store#</b> _____
<b>Location</b> _____	<b>Quantity</b> _____



**Food Preparation Deli/Pizza Units**  
**Models: DP46, DP67, DP93, DP119**

MODEL	DP46	DP67	DP93	DP119
<b>EXTERNAL DIMENSIONAL DATA</b>				
Length Overall (inches)	46"	67"	93"	119"
Length Overall (mm)	1168	1702	2362	3023
Depth Overall (inches)	38 3/8"	38 3/8"	38 3/8"	38 3/8"
Depth Overall (mm)	975	975	975	975
Height Overall—(inches)	43 3/8"	43 3/8"	43 3/8"	43 3/8"
Height Overall—(mm)	1102	1102	1102	1102
Number of doors	1	2	3	4
Depth with Door Open 90 °	57"	57"	57"	57"
Clear Door Opening (inches)	21 1/2" x 23 1/2"	21 1/2" x 23 1/2"	21 1/2" x 23 1/2"	21 1/2" x 23
<b>INTERNAL DIMENSIONAL DATA</b>				
NET Capacity (cubic ft.)	16.7	27	39.8	52.5
NET Capacity (Liters)	473	765	1127	1487
Internal Length Overall (inches)	26"	48"	75 1/4"	100"
Internal Length Overall (mm)	660	1219	1911	2540
Internal Depth Overall (inches)	28"	28"	28"	28"
Internal Depth Overall (mm)	711	711	711	711
Internal Height Overall—(inches)	24"	24"	24"	24"
Internal Height Overall—(mm)	610	610	610	610
Number of shelves	2	4	6	8
<b>ELECTRICAL DATA</b>				
Full Load Amperes 115/60/1	6.3	6.3	8.6	8.6
<b>ENERGY CONSUMPTION (KWH)</b>				
	.27	.23	.36	.46
<b>REFRIGERATION DATA</b>				
Horsepower	1/4	1/4	1/3	1/3
<b>WEIGHT DATA</b>				
Gross Weight (Crated lbs)	338	464	580	703
Gross Weight (Crated kg)	153	211	263	319

**PLAN VIEWS**

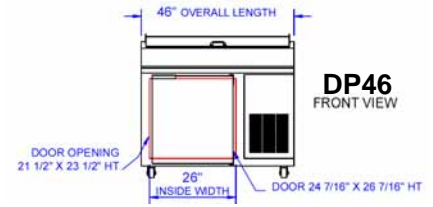

**DP46**  
FRONT VIEW

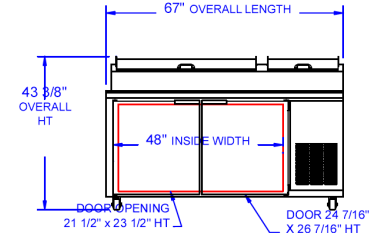

**DP67** FRONT VIEW

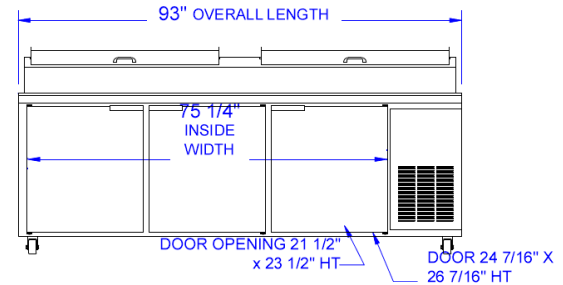

**DP93** FRONT VIEW

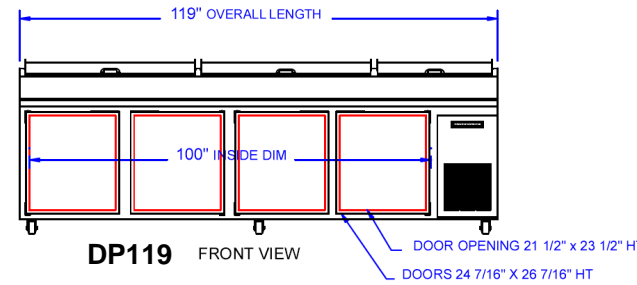

**DP119** FRONT VIEW

**DP46 TOP**

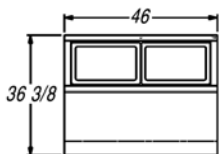

**DP93 TOP**

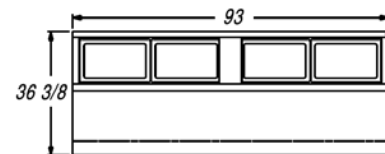

**DP67 TOP**

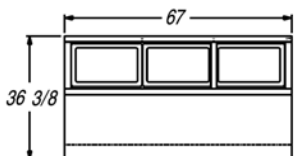

**DP119 TOP**

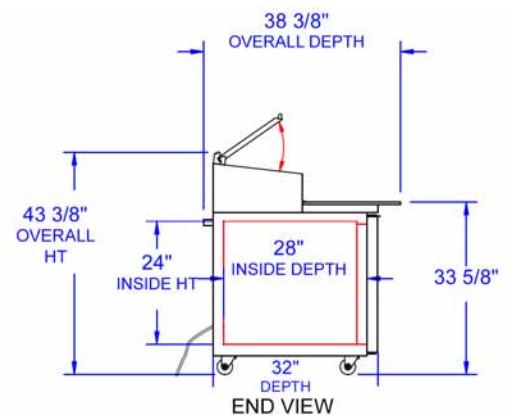
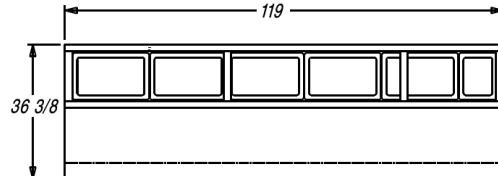

**END VIEW**



**BEVERAGE-AIR® CORPORATION**

3779 Champion Blvd. • Winston-Salem, NC 27105 USA • (336) 245-6400 • Fax (336) 245-6453 • (888) 845-9800 • www.beverage-air.com

Specifications are subject to change without prior notice. 07/10