



BEVERAGE-AIR

PO Box 5932, Spartanburg, SC 29304
1-888-845-9800 Fax# 1-864-582-5083
<http://www.Beverage-Air.com>

Commercial Refrigeration Equipment General Specification

WTRD SERIES—29" DEPTH

Versatile, compact (29" depth) with stainless steel work tops and 4" high removable backsplash for refrigerated storage of food products. Working height is 35 1/2".

CABINET CONSTRUCTION

Heavy duty construction includes exterior stainless steel on front, sides, door(s) and grille. Cabinet back and bottom are galvanized steel. Interior liner is made of corrosion resistant anodized aluminum. Interior thermometer is standard.

In cabinets with doors and drawers, doors are mounted to face of cabinet on cartridge-style hinges permitting them to self close under their own weight. Hinges also allow doors to stay open 120° and permit easy door removal for service and cleaning if required. A plug-in type vinyl magnetic gasket is attached to each door for positive seal.

Cabinet insulation is CFC and HCFC-free foamed-in-place polyurethane of two-inch minimum thickness. Units are supplied with 6" high casters. Front casters have wheel locking mechanism.

DRAWER CONSTRUCTION

Drawer frames are constructed of heavy-duty stainless steel. Telescoping design slides make opening drawers smooth and easy. Heavy duty construction ensures maximum support of stored food products. Slides have locking mechanism to prevent drawers from being pulled off of cabinets. For your convenience, drawers accommodate 6" or 4" deep pans. Heavy-duty pan divider supports are supplied. Foodservice pans for drawers are not included. Snap-type vinyl magnetic gasket is attached to each drawer for positive seal. Drawers extend 17" (when opened).

REFRIGERATION

Robust and balanced refrigeration system ensures that food stays fresh for a longer period of time. Optimum air flow inside cabinets helps in keeping uniform temperature within the cabinet. Refrigeration system uses environment friendly R134a refrigerant which is CFC and HCFC-free. Design utilizes automatic condensate removal process.

ELECTRICAL

Units wired at factory and ready for connection to a 115/60/1 phase, 15 amp dedicated outlet. 8' long cord and plug set included.

ELECTRICAL CONNECTION

Units pre-wired at factory and include 8' long cord and plug



Item No. _____
Quantity _____

WORKTOP REFRIGERATORS WITH DRAWERS WTRD 29" DEPTH SERIES

MODELS:
WTRD27A
WTRD48A
WTRD60A
WTRD72A



WTRD27A-2



WTRD48A-2

Available From:



*Note: Not all markings may apply to all model variations.

Model Specified _____

Store# _____

Location _____

Quantity _____



Undercounter Refrigerator With Drawers
Models: WTRD27A, WTRD48A, WTRD60A, WTRD72A

MODEL	WTRD27A-2	WTRD48A-2	WTRD48A-4	WTRD60A-2	WTRD60A-4	WTRD72A-2	WTRD72A-4	WTRD72A-6
EXTERNAL DIMENSIONAL DATA								
Length Overall (inches)	27"	48"	48"	60"	60"	72"	72"	72"
Length Overall (mm)	686	1219	1219	1524	1524	1829	1829	1829
Depth Overall (inches)	29 1/4"	29 1/4"	29 1/4"	29 1/4"	29 1/4"	29 1/4"	29 1/4"	29 1/4"
Depth Overall (mm)	743	743	743	743	743	743	743	743
Height Overall—(inches)	39 1/2"	39 1/2"	39 1/2"	39 1/2"	39 1/2"	39 1/2"	39 1/2"	39 1/2"
Height Overall—(mm)	1003	1003	1003	1003	1003	1003	1003	1003
Number of doors	-	1	-	1	-	2	1	-
Number of drawers	2	2	4	2	4	2	4	6
Drawer Extension (when opened)	17"	17"	17"	17"	17"	17"	17"	17"
INTERNAL DIMENSIONAL DATA								
NET Capacity (cubic ft.)	7.3	13.9	13.9	17.1	17.1	21.5	21.5	21.5
NET Capacity (Liters)	207	394	394	484	484	609	609	609
Internal Length Overall (inches)	23"	44"	44"	55 7/8"	55 7/8"	68"	68"	68"
Internal Length Overall (mm)	584	1118	1118	1419	1419	1727	1727	1727
Internal Depth Overall (inches)	19"	19"	19"	19"	19"	19"	19"	19"
Internal Depth Overall (mm)	483	483	483	483	483	483	483	483
Internal Height Overall—(inches)	23"	23"	23"	23"	23"	23"	23"	23"
Internal Height Overall—(mm)	584	584	584	584	584	584	584	584
Number of shelves	-	2	-	2	-	4	2	-
ELECTRICAL DATA								
Full Load Amperes 115/60/1	4	3.3	3.3	8.2	8.2	8.2	8.2	8.2
REFRIGERATION DATA								
Horsepower	1/6	1/5	1/5	1/4	1/4	1/4	1/4	1/4
WEIGHT DATA								
Gross Weight (Crated lbs)	184	242	242	271	271	330	330	330
Gross Weight (Crated kg)	84	110	110	123	123	150	150	150

PLAN VIEWS

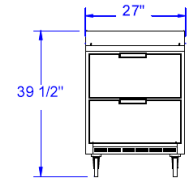

FRONT VIEW
WTRD27A-2

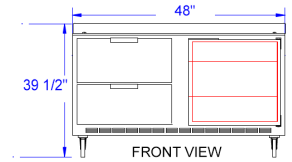

WTRD48A-2

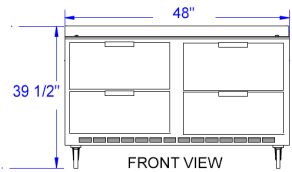

WTRD48A-4

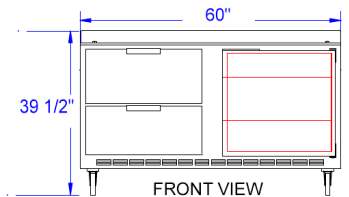

WTRD60A-2

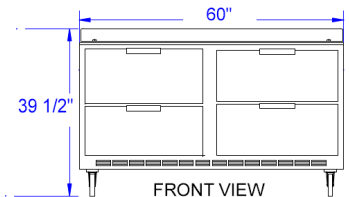

WTRD60A-4



Note: Not all markings may apply to all model variations.
 *N/A: Not available at time of printing.

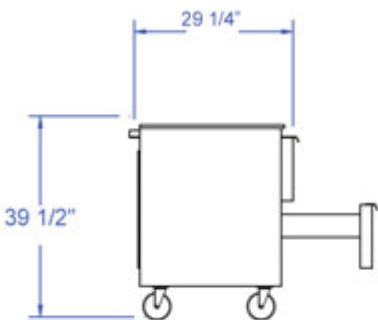

END VIEW

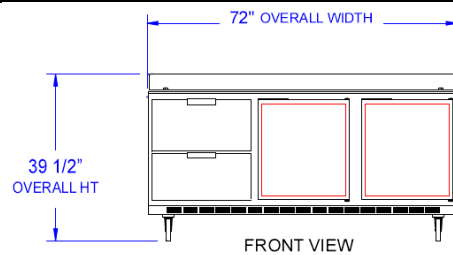

WTRD72A-2

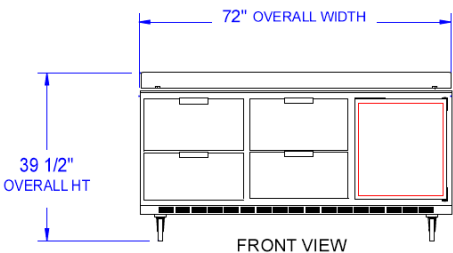

WTRD72A-4

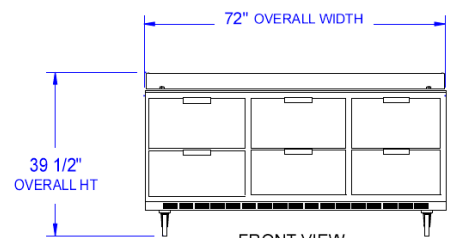

WTRD72A-6

BEVERAGE-AIR® CORPORATION

700 Buffington Road • PO Box 5932 • Spartanburg, SC 29304 USA • (864) 582-8111 • Fax (864) 582-5083 • (888) 845-9800 • www.beverage-air.com

Specifications are subject to change without prior notice. 07/09